

## Potential distributors - VIP-3/PT/PDM-2/24 - 2903798

Please be informed that the data shown in this PDF Document is generated from our Online Catalog. Please find the complete data in the user's documentation. Our General Terms of Use for Downloads are valid (<http://phoenixcontact.com/download>)



VARIOFACE module with push-in connection and two equipotential busbars (P1, P2) for potential distribution, for mounting on NS 35 rails. Module width: 57.1 mm



### Key Commercial Data

Packing unit	1 pc
GTIN	 4 046356 796729
GTIN	4046356796729

### Technical data

#### Note

Type of note	Type of insulation housing
Note	Polyamide PA non-reinforced

#### Dimensions

Width	57.1 mm
Height	75.5 mm
Depth	63 mm

#### Ambient conditions

Ambient temperature (operation)	-20 °C ... 50 °C
Ambient temperature (storage/transport)	-20 °C ... 70 °C

#### General

Nominal voltage $U_N$	250 V AC/DC
Max. current carrying capacity per branch	15 A
Total current	30 A (per potential)
Potential connections	Per potential (P1, P2) 2 power/12 distributor terminal blocks
Mounting position	any

## Potential distributors - VIP-3/PT/PDM-2/24 - 2903798

### Technical data

#### Connection data

Connection name	Service Entrance
Connection method	Push-in-/Spring-cage connection
Stripping length	15 mm
Number of connections	2
Conductor cross section solid	0.25 mm <sup>2</sup> ... 6 mm <sup>2</sup>
Conductor cross section flexible	0.25 mm <sup>2</sup> ... 4 mm <sup>2</sup>
Conductor cross section AWG	24 ... 10

#### Connection data 2

Connection name	Distribution
Connection method	Push-in connection
Stripping length	8 mm
Number of connections	24
Conductor cross section solid	0.14 mm <sup>2</sup> ... 2.5 mm <sup>2</sup>
Conductor cross section flexible	0.14 mm <sup>2</sup> ... 2.5 mm <sup>2</sup>
Conductor cross section AWG	26 ... 14

#### Standards and Regulations

Connection in acc. with standard	CSA
Standards/regulations	IEC 60664
	DIN EN 50178
Pollution degree	2
Overvoltage category	III

#### Environmental Product Compliance

China RoHS	Environmentally Friendly Use Period = 50 years
	For details about hazardous substances go to tab "Downloads", Category "Manufacturer's declaration"

### Drawings

# Potential distributors - VIP-3/PT/PDM-2/24 - 2903798

Dimensional drawing

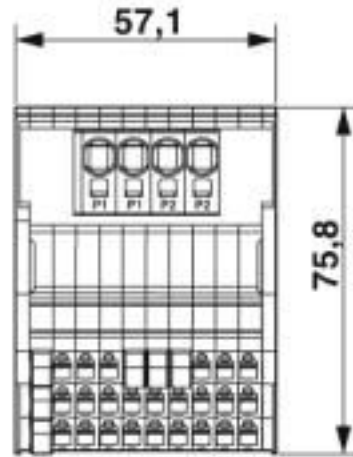
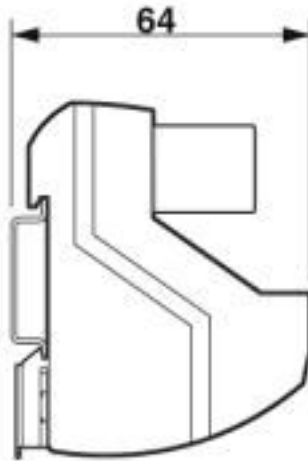

P2 .01 .02 .03 .04 .05 .06 .07 .08 .09 ← MIDDLE ROW MARKING

P1 .01 .02 .03 .04 .05 .06 .07 .08 .09 ← BOTTOM ROW MARKING

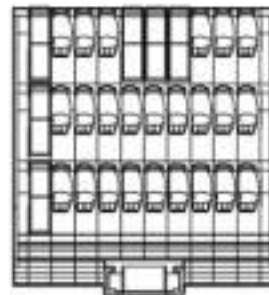

## Potential distributors - VIP-3/PT/PDM-2/24 - 2903798

Circuit diagram

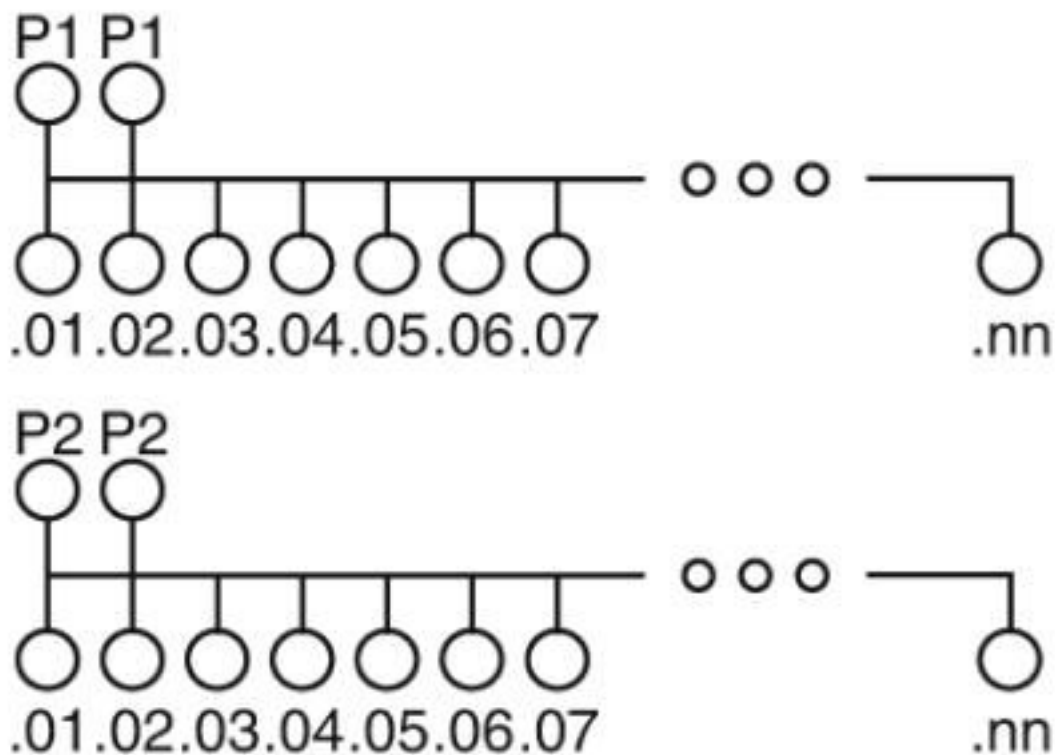

### Classifications

#### eCl@ss

eCl@ss 10.0.1	27400609
eCl@ss 4.0	27250300
eCl@ss 4.1	27250300
eCl@ss 5.0	27250300
eCl@ss 5.1	27250300
eCl@ss 6.0	27400600
eCl@ss 7.0	27400609
eCl@ss 8.0	27400609
eCl@ss 9.0	27400609

#### ETIM

ETIM 4.0	EC001894
ETIM 5.0	EC001894
ETIM 6.0	EC001894
ETIM 7.0	EC001894

#### UNSPSC

UNSPSC 6.01	30211824
-------------	----------

# Potential distributors - VIP-3/PT/PDM-2/24 - 2903798

## Classifications

### UNSPSC

UNSPSC 7.0901	39121421
UNSPSC 11	39121421
UNSPSC 12.01	39121421
UNSPSC 13.2	39121432
UNSPSC 19.0	39121432

## Approvals

### Approvals

#### Approvals

CSA / UL Recognized / cUL Recognized / EAC / cULus Recognized

#### Ex Approvals

### Approval details

CSA		<a href="http://www.csagroup.org/services-industries/product-listing/">http://www.csagroup.org/services-industries/product-listing/</a>	2122203
Nominal voltage UN		250 V	
Nominal current IN		15 A	
mm <sup>2</sup> /AWG/kcmil		26-14	

UL Recognized		<a href="http://database.ul.com/cgi-bin/XYV/template/LISEXT/1FRAME/index.htm">http://database.ul.com/cgi-bin/XYV/template/LISEXT/1FRAME/index.htm</a>	FILE E 238705
Nominal voltage UN		250 V	
Nominal current IN		15 A	
mm <sup>2</sup> /AWG/kcmil		26-14	

cUL Recognized		<a href="http://database.ul.com/cgi-bin/XYV/template/LISEXT/1FRAME/index.htm">http://database.ul.com/cgi-bin/XYV/template/LISEXT/1FRAME/index.htm</a>	FILE E 238705
Nominal voltage UN		250 V	
Nominal current IN		15 A	
mm <sup>2</sup> /AWG/kcmil		26-14	

## Potential distributors - VIP-3/PT/PDM-2/24 - 2903798

### Approvals

EAC		RU C- DE.A*30.B.01742
-----	---	--------------------------

cULus Recognized	
------------------	---

Phoenix Contact 2020 © - all rights reserved  
<http://www.phoenixcontact.com>

PHOENIX CONTACT GmbH & Co. KG  
Flachsmarktstr. 8  
32825 Blomberg  
Germany  
Tel. +49 5235 300  
Fax +49 5235 3 41200  
<http://www.phoenixcontact.com>