

T distributor - QPD T3PE2,5 2X9-14 BK - 1424048

Please be informed that the data shown in this PDF Document is generated from our Online Catalog. Please find the complete data in the user's documentation. Our General Terms of Use for Downloads are valid (<http://phoenixcontact.com/download>)



T distributor, QUICKON connection, number of positions: 3+PE, 1 mm² ... 2.5 mm², 690 V, 20 A, black, With two QUICKON nuts, cable diameter range: 9 mm ... 14 mm

Your advantages

- ✔ Innovative and time saving - QUICKON fast connection for time saving of up to 80 % for on-site connection
- ✔ Convenient: quick and easy assembly without special tools
- ✔ Robust throughout: housing with IP68/IP69K and IK07 protection for a wide range of applications
- ✔ Safer connection thanks to polarization against mismatching and touch-proof protection according to DIN EN 0105
- ✔ Flexible and compact - by connecting connections internally, H and T-distributors can be used to branch master cables or they can be used as star distributors



Key Commercial Data

Packing unit	1 pc
GTIN	 4 055626 366500
GTIN	4055626366500

Technical data

General

Type	T-distributor
Color	black
Locking type	Screw locking
Connection method	QUICKON connection
	IDC connection
Number of positions	4
Note number of positions	3+PE
Wrench size, union nut	22 mm
Tightening torque, union nut	7 Nm
Number of connections	3

T distributor - QPD T3PE2,5 2X9-14 BK - 1424048

Technical data

General

Conductor cross section flexible min.	1 mm ²
Conductor cross section flexible max.	2.5 mm ²
Conductor cross section solid min.	1 mm ²
Conductor cross section solid max.	2.5 mm ²
Conductor cross section AWG min.	16
Conductor cross section AWG max.	14

Cabel

Structure of individual litz in acc. with VDE 0295 / smallest wire diameter	VDE 0295 class 1 to 6/min. 0.15 mm
Wire insulation material	PVC/PE/TPE/rubber
Wire diameter including insulation	2 mm ... 3.6 mm
External cable diameter	9 mm ... 14 mm
Position marking	1, 2, 3, PE

Ambient conditions

Degree of protection	IP66
	IP68 (2 m / 24 h)
	IP69K (Distance from the nozzle 150 mm)
Ambient temperature (operation)	-40 °C ... 100 °C
Ambient temperature (storage/transport)	-40 °C ... 100 °C
Temperature when conductor connected	-5 °C ... 50 °C

Electrical characteristics

Nominal current I _N	20 A
Nominal voltage U _N	690 V AC
	690 V DC
Rated current	20 A
rated voltage (III/3)	690 V
rated voltage (III/2)	690 V
rated voltage (II/2)	1000 V
Rated surge voltage (III/3)	6 kV
Rated surge voltage (III/2)	6 kV
Rated surge voltage (II/2)	6 kV

Mechanical characteristics

QUICKON connectability	max. 10
Insertion/withdrawal cycles	max. 50
Category of shock impact	IK07 (-25 °C)

Material data

Contact material	Cu
Contact surface material	silver-plated
Contact carrier material	PA

T distributor - QPD T3PE2,5 2X9-14 BK - 1424048

Technical data

Material data

Insulating material	PA
Flammability rating according to UL 94	V0
Overvoltage category	III
Degree of pollution	3

Standards and Regulations

Category of shock impact	IK07 (-25 °C)
Halogen-free	yes
Flammability rating according to UL 94	V0

Environmental Product Compliance

REACH SVHC	Lead 7439-92-1
China RoHS	Environmentally Friendly Use Period = 50 years
	For details about hazardous substances go to tab "Downloads", Category "Manufacturer's declaration"

Drawings

Diagram

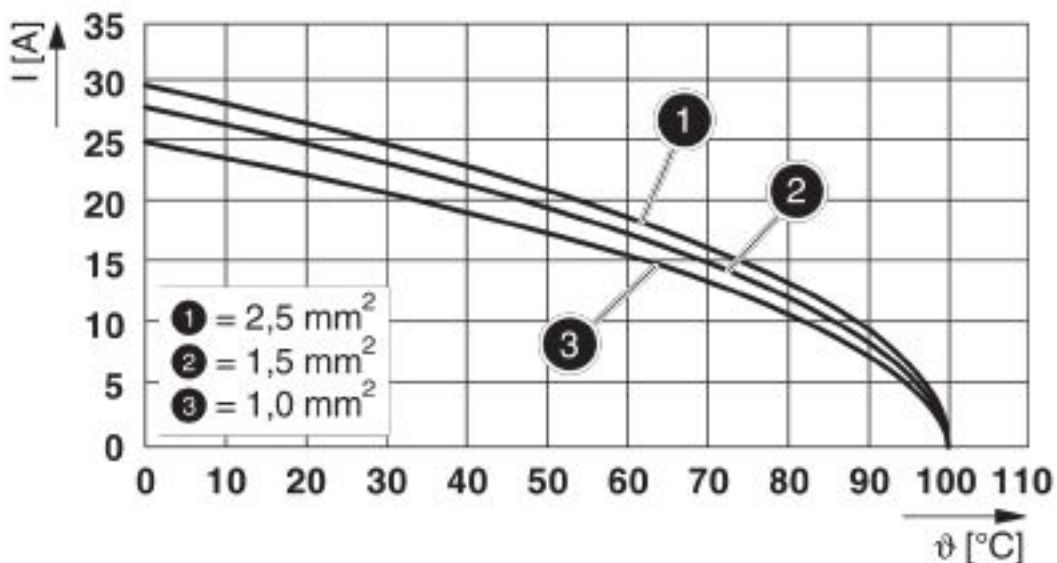

Derating diagram

T distributor - QPD T3PE2,5 2X9-14 BK - 1424048

Dimensional drawing

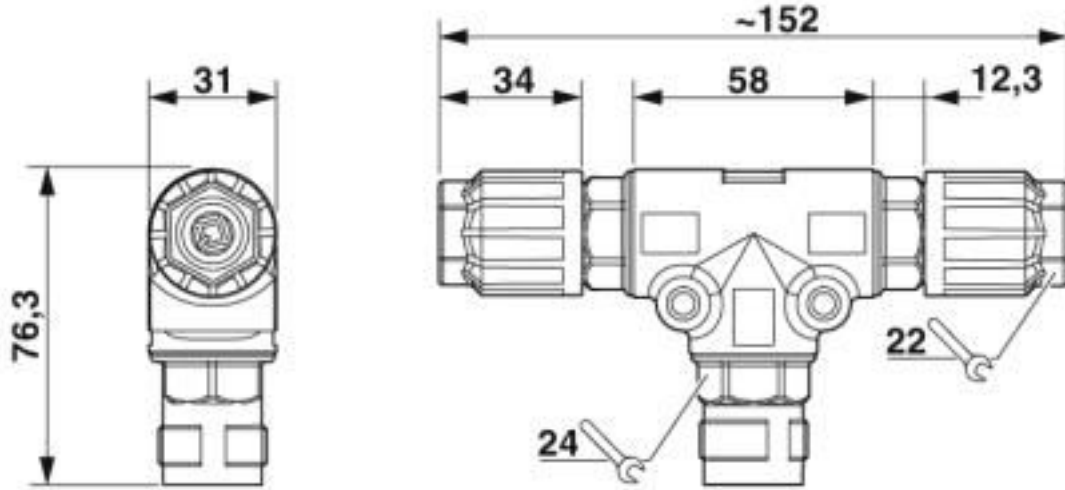

Dimensional drawing

Circuit diagram

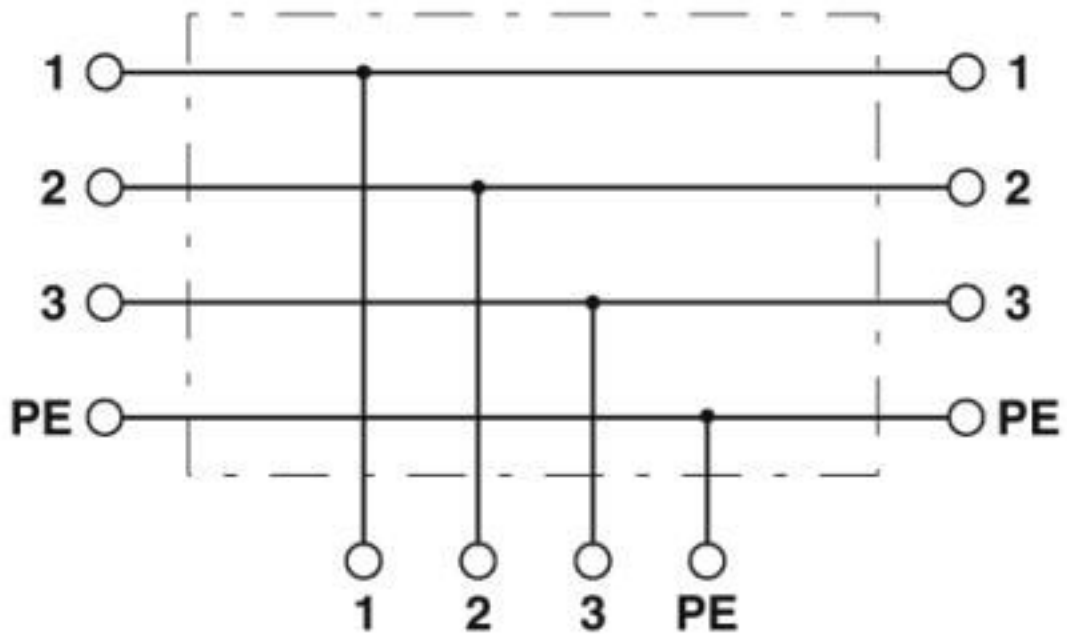

Classifications

eCl@ss

eCl@ss 10.0.1	27440603
eCl@ss 11.0	27440603
eCl@ss 7.0	27440603
eCl@ss 8.0	27440603

T distributor - QPD T3PE2,5 2X9-14 BK - 1424048

Classifications

eCl@ss

eCl@ss 9.0	27440603
------------	----------

ETIM

ETIM 6.0	EC002567
ETIM 7.0	EC002567

Approvals

Approvals

Approvals

EAC / IECEE CB Scheme / UL Listed / cUL Listed / VDE Zeichengenehmigung / cULus Listed

Ex Approvals

Approval details

EAC			RU C- DE.BL08.B.00511
-----	---	--	--------------------------

IECEE CB Scheme		http://www.iecee.org/	DE1-61559
-----------------	---	---	-----------

UL Listed		http://database.ul.com/cgi-bin/XYV/template/LISEXT/1FRAME/index.htm	E468743
-----------	---	---	---------

Nominal voltage UN	600 V
Nominal current IN	15 A
mm ² /AWG/kcmil	14

cUL Listed		http://database.ul.com/cgi-bin/XYV/template/LISEXT/1FRAME/index.htm	E468743
------------	---	---	---------

Nominal voltage UN	600 V
Nominal current IN	15 A
mm ² /AWG/kcmil	14

T distributor - QPD T3PE2,5 2X9-14 BK - 1424048

Approvals

VDE Zeichengenehmigung		http://www2.vde.com/de/Institut/Online-Service/VDE-gepruefteProdukte/Seiten/Online-Suche.aspx	40029149
Nominal voltage UN		690 V	
Nominal current IN		20 A	
mm ² /AWG/kcmil		1-2.5	

cULus Listed	
--------------	--

Accessories

Accessories

Coding element

Coding profile - CP QPD 4X2,5 - 1425950



Coding profile red, for pushing into the QUICKON dome and connector, can be positioned in 90° steps.

Protective cap

Protective cap - QPD QSK 5X1,5 - 1414758



Protective cap plastic, for QPD-QUICKON connection 5x 1.5 mm², IP50

Protective cap - QPD QSK BK 5X1,5 FS - 1414728

Protective cap, plastic, for QUICKON connection, black, with retaining cord, IP68



Socket spanner

T distributor - QPD T3PE2,5 2X9-14 BK - 1424048

Accessories

Socket wrench - QSS 22 - 1670206



Allen wrench, for loosening and fastening the QUICKON union nut, WAF 22 mm

Phoenix Contact 2020 © - all rights reserved
<http://www.phoenixcontact.com>

PHOENIX CONTACT GmbH & Co. KG
Flachsmarktstr. 8
32825 Blomberg
Germany
Tel. +49 5235 300
Fax +49 5235 3 41200
<http://www.phoenixcontact.com>