

# Printed-circuit board connector - MSTBA 2,5/ 5-G - 1757501

Please be informed that the data shown in this PDF Document is generated from our Online Catalog. Please find the complete data in the user's documentation. Our General Terms of Use for Downloads are valid (<http://phoenixcontact.com/download>)

PCB headers, nominal cross section: 2.5 mm<sup>2</sup>, color: green, nominal current: 12 A, rated voltage (III/2): 320 V, contact surface: Tin, type of contact: Male connector, Number of potentials: 5, Number of rows: 1, Number of positions per row: 5, number of connections: 5, product range: MSTBA 2,5/..-G, pitch: 5 mm, mounting: Wave soldering, pin layout: Linear pinning, solder pin [P]: 3.5 mm, Stecksystem: CLASSIC COMBICON, Locking: without, type of packaging: packed in cardboard



The figure shows a 10-position version of the product

## Your advantages

- ✓ Maximum flexibility when it comes to device design – one header for connectors with different connection technologies
- ✓ Well-known mounting principle allows worldwide use
- ✓ Plug-in direction parallel to the PCB
- ✓ Closed contour for optimum stability of the plug-in connection
- ✓ Easy PCB replacement thanks to plug-in modules



## Key Commercial Data

Packing unit	250 pc
Minimum order quantity	250 pc
GTIN	
GTIN	4017918030032

## Technical data

### Item properties

Brief article description	Feed-through header
Plug-in system	CLASSIC COMBICON
Type of contact	Male connector
Range of articles	MSTBA 2,5/..-G
Pitch	5 mm
Number of positions	5
Mounting type	Wave soldering
Pin layout	Linear pinning
Locking	without

# Printed-circuit board connector - MSTBA 2,5/ 5-G - 1757501

## Technical data

### Item properties

Number of levels	1
Number of connections	5
Number of potentials	5

### Electrical parameters

Nominal current	12 A
Nom. voltage	320 V
Rated voltage	320 V
Rated voltage (III/2)	320 V
Rated voltage (II/2)	630 V
Rated surge voltage (III/3)	4 kV
Rated surge voltage (III/2)	4 kV
Rated surge voltage (II/2)	4 kV

### Material data - contact

Note	WEEE/RoHS-compliant, free of whiskers according to IEC 60068-2-82/ JEDEC JESD 201
Contact material	Cu alloy
Surface characteristics	Tin-plated
Metal surface contact area (top layer)	Tin (3 - 5 µm Sn)
Metal surface contact area (middle layer)	Nickel (1 - 3 µm Ni),
Metal surface soldering area (top layer)	Tin (3 - 5 µm Sn)
Metal surface soldering area (middle layer)	Nickel (1 - 3 µm Ni)

### Material data - housing

Housing color	green (6021)
Insulating material	PA
Insulating material group	I
CTI according to IEC 60112	600
Flammability rating according to UL 94	V0
Glow wire flammability index GWFI according to EN 60695-2-12	850
Glow wire ignition temperature GWIT according to EN 60695-2-13	775
Temperature for the ball pressure test according to EN 60695-10-2	125 °C

### Dimensions for the product

Caption	Schematische Abbildung - weitere Details siehe Produktfamilienzeichnung im Download Center
Length [ l ]	12 mm
Width [ w ]	27 mm
Height [ h ]	12.1 mm
Pitch	5 mm
Height (without solder pin)	8.6 mm
Solder pin [P]	3.5 mm
Pin dimensions	1 x 1 mm

# Printed-circuit board connector - MSTBA 2,5/ 5-G - 1757501

## Technical data

### Dimensions for PCB design

Hole diameter	1.4 mm
---------------	--------

### Packaging information

Type of packaging	packed in cardboard
Pieces per package	250
Denomination packing units	Pcs.
Outer packaging type	Carton

### General product information

Type of note	Notes on operation
Note	In accordance with IEC 61984, COMBICON connectors have no switching power (COC). During designated use, they must not be plugged in or disconnected when carrying voltage or under load.

### Ambient conditions

Ambient temperature (storage/transport)	-40 °C ... 70 °C
Ambient temperature (assembly)	-5 °C ... 100 °C
Ambient temperature (operation)	-40 °C ... 100 °C (dependent on the derating curve)

### Air clearances and creepage distances

Clearances and creepage distances	IEC 60664-1:2007-04
Specification	IEC 60664-1:2007-04
Minimum clearance - inhomogeneous field (III/3)	3 mm
Minimum clearance - inhomogeneous field (III/2)	3 mm
Minimum clearance - inhomogeneous field (II/2)	3 mm
Minimum creepage distance value (III/3)	4 mm
Minimum creepage distance value (III/2)	1.6 mm
Minimum creepage distance value (II/2)	3.2 mm

### Standards and Regulations

Connection in acc. with standard	EN-VDE
	CSA
Flammability rating according to UL 94	V0

### Environmental Product Compliance

China RoHS	Environmentally friendly use period: unlimited = EFUP-e
	No hazardous substances above threshold values

## Drawings

# Printed-circuit board connector - MSTBA 2,5/ 5-G - 1757501

Drilling diagram

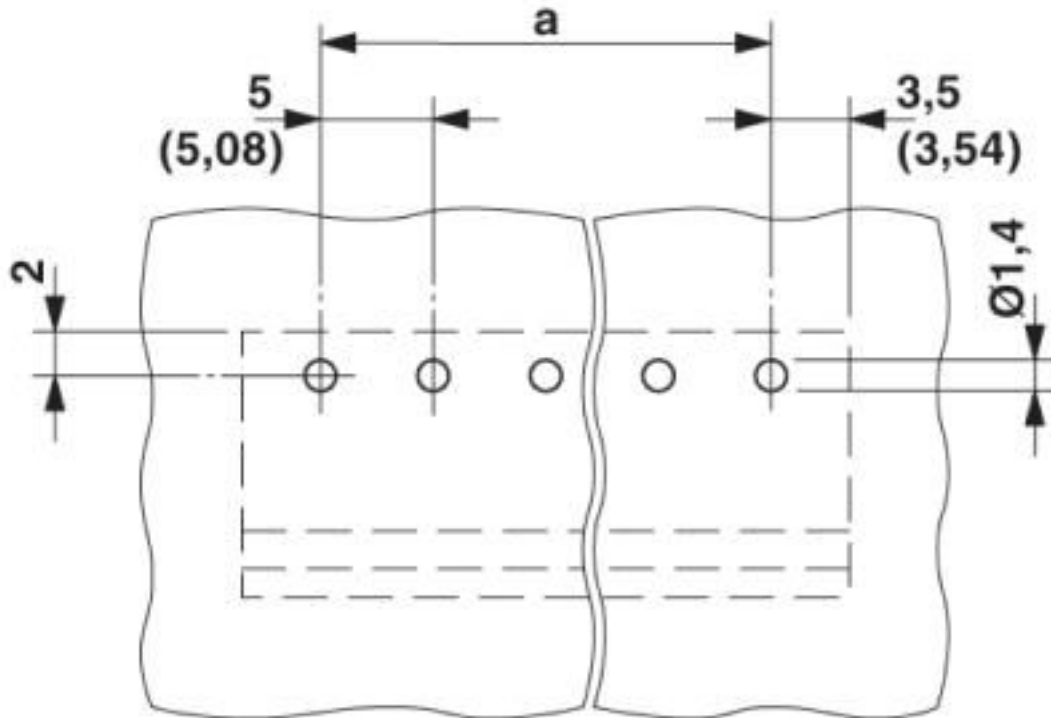

Diagram

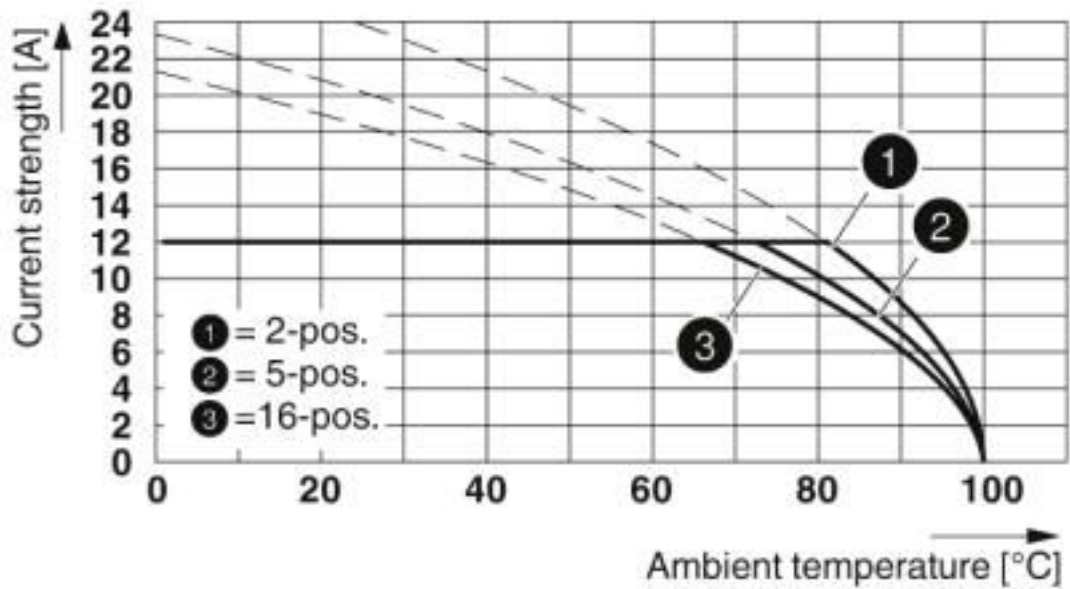

Type: FKCVR 2,5/...-ST with MSTBA 2,5/...-G

# Printed-circuit board connector - MSTBA 2,5/ 5-G - 1757501

Diagram

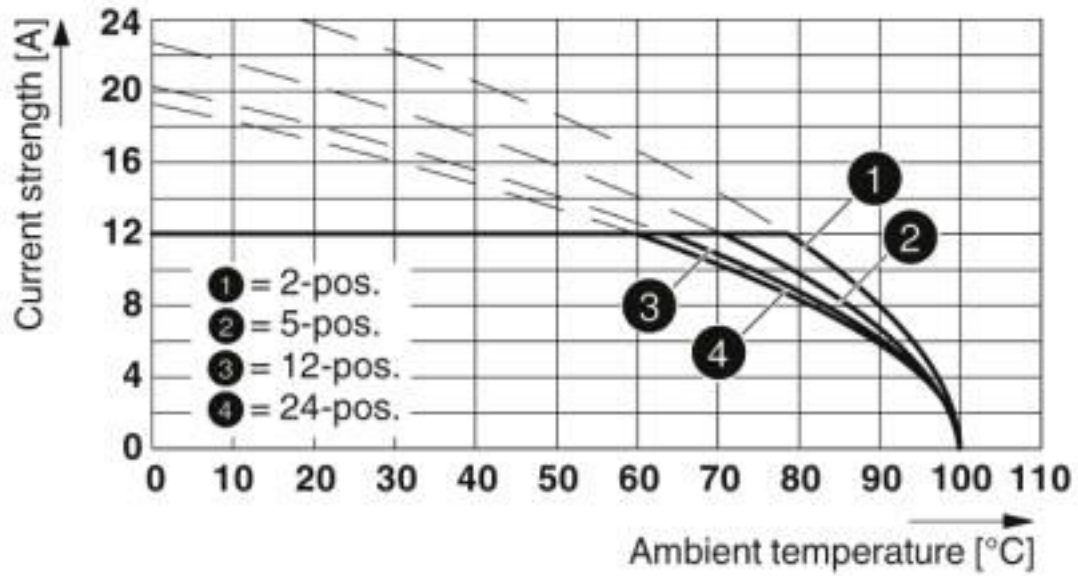

Type: MSTBP 2,5/...-ST with MSTBA 2,5/...-G

Dimensional drawing

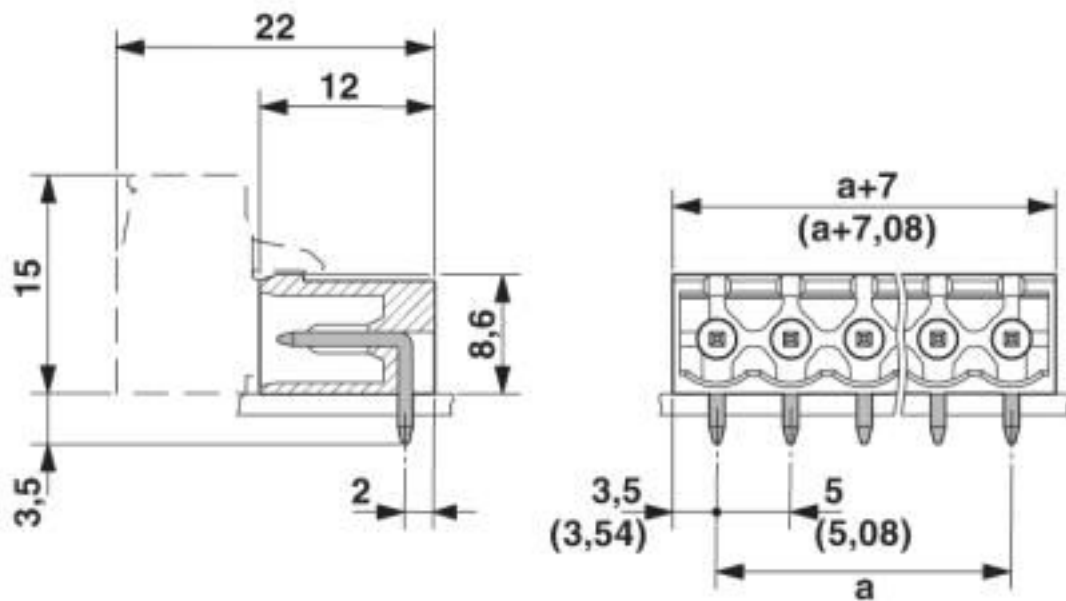

## Classifications

eCl@ss

eCl@ss 10.0.1	27440402
eCl@ss 11.0	27460201
eCl@ss 4.0	27260700

# Printed-circuit board connector - MSTBA 2,5/ 5-G - 1757501

## Classifications

### eCl@ss

eCl@ss 4.1	27260700
eCl@ss 5.0	27260700
eCl@ss 5.1	27260700
eCl@ss 6.0	27260700
eCl@ss 7.0	27440402
eCl@ss 8.0	27440402
eCl@ss 9.0	27440402

### ETIM

ETIM 3.0	EC001121
ETIM 4.0	EC002637
ETIM 5.0	EC002637
ETIM 6.0	EC002637
ETIM 7.0	EC002637

### UNSPSC

UNSPSC 6.01	30211810
UNSPSC 7.0901	39121409
UNSPSC 11	39121409
UNSPSC 12.01	39121409
UNSPSC 13.2	39121409
UNSPSC 18.0	39121409
UNSPSC 19.0	39121409
UNSPSC 20.0	39121409
UNSPSC 21.0	39121409

## Approvals

### Approvals

---

#### Approvals

CSA / IECCEB CB Scheme / EAC / cULus Recognized / VDE Zeichengenehmigung

---

#### Ex Approvals

---

### Approval details

# Printed-circuit board connector - MSTBA 2,5/ 5-G - 1757501

## Approvals

CSA		<a href="http://www.csagroup.org/services-industries/product-listing/">http://www.csagroup.org/services-industries/product-listing/</a>	LR13631-2585950
		B	D
Nominal voltage UN		300 V	300 V
Nominal current IN		10 A	10 A

IECEE CB Scheme		<a href="http://www.iecee.org/">http://www.iecee.org/</a>	DE1-60988-B1B2
Nominal voltage UN		250 V	
Nominal current IN		12 A	

EAC			B.01687
-----	--	--	---------

cULus Recognized		<a href="http://database.ul.com/cgi-bin/XYV/template/LISEXT/1FRAME/index.htm">http://database.ul.com/cgi-bin/XYV/template/LISEXT/1FRAME/index.htm</a>	E60425-19931011
		B	D
Nominal voltage UN		300 V	300 V
Nominal current IN		15 A	10 A

VDE Zeichengenehmigung		<a href="http://www2.vde.com/de/Institut/Online-Service/VDE-gepruefteProdukte/Seiten/Online-Suche.aspx">http://www2.vde.com/de/Institut/Online-Service/VDE-gepruefteProdukte/Seiten/Online-Suche.aspx</a>	40050648
Nominal voltage UN		250 V	
Nominal current IN		12 A	

## Accessories

Accessories

Coding element

Coding section - CR-MSTB - 1734401

Coding section, inserted into the recess in the header or the inverted plug, red insulating material



## Printed-circuit board connector - MSTBA 2,5/ 5-G - 1757501

### Accessories

---

#### Filler plug

Accessories - MSTB-BL - 1755477



Keying cap, for forming sections, plugs onto header pin, green insulating material

---

#### Labeled terminal marker

Marker card - SK 5/3,8:FORTL.ZAHLEN - 0804183



Marker card, Card, white, labeled, horizontal: consecutive numbers 1 ... 10, 11 ... 20, etc. up to 91 ... (99)100, mounting type: adhesive, for terminal block width: 5 mm, lettering field size: 5 x 3.8 mm

---

#### Marker pen

Marker pen - B-STIFT - 1051993



Marker pen, for manual labeling of unprinted Zack strips, smear-proof and waterproof, line thickness 0.5 mm

---

#### Terminal marking

Marker card - SK 5/3,8:UNBEDRUCKT - 0805409



Marker card, Card, white, unlabeled, can be labeled with: Marker pen, mounting type: adhesive, for terminal block width: 5 mm, lettering field size: 5 x 3.8 mm

---

#### Additional products



## Printed-circuit board connector - MSTBA 2,5/ 5-G - 1757501

### Accessories

#### Printed-circuit board connector - TVFKC 1,5/ 5-ST - 1713868

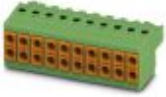

PCB connector, nominal cross section: 1.5 mm<sup>2</sup>, color: green, nominal current: 10 A, rated voltage (III/2): 320 V, contact surface: Tin, type of contact: Female connector, Number of potentials: 5, Number of rows: 1, Number of positions per row: 5, number of connections: 10, product range: TVFKC 1,5/..-ST, pitch: 5 mm, connection method: Push-in spring connection, conductor/PCB connection direction: 0 °, Stecksystem: CLASSIC COMBICON, Locking: without, type of packaging: packed in cardboard

#### Printed-circuit board connector - TVFKCL 1,5/ 5-ST - 1715950

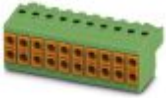

PCB connector, nominal cross section: 1.5 mm<sup>2</sup>, color: green, nominal current: 10 A, rated voltage (III/2): 320 V, contact surface: Tin, type of contact: Female connector, Number of potentials: 5, Number of rows: 1, Number of positions per row: 5, number of connections: 10, product range: TVFKCL 1,5/..-ST, pitch: 5 mm, connection method: Push-in spring connection, conductor/PCB connection direction: 0 °, Stecksystem: CLASSIC COMBICON, Locking: without, type of packaging: packed in cardboard

#### Plug - QC 1,5/ 5-ST - 1717990

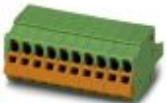

PCB connector, nominal cross section: 1.5 mm<sup>2</sup>, color: green, nominal current: 12 A, rated voltage (III/2): 630 V, contact surface: Tin, type of contact: Female connector, Number of potentials: 5, Number of rows: 1, Number of positions per row: 5, number of connections: 5, product range: QC 1,5/..-ST, pitch: 5 mm, connection method: Displacement connection, conductor/PCB connection direction: 0 °, Stecksystem: CLASSIC COMBICON, Locking: without, type of packaging: packed in cardboard

#### Printed-circuit board connector - FKCN 2,5/ 5-ST - 1732771



PCB connector, nominal cross section: 2.5 mm<sup>2</sup>, color: green, nominal current: 12 A, rated voltage (III/2): 320 V, contact surface: Tin, type of contact: Female connector, Number of potentials: 5, Number of rows: 1, Number of positions per row: 5, number of connections: 5, product range: FKCN 2,5/..-ST, pitch: 5 mm, connection method: Push-in spring connection, conductor/PCB connection direction: 0 °, Stecksystem: CLASSIC COMBICON, Locking: without, type of packaging: packed in cardboard

#### Printed-circuit board connector - MSTB 2,5/ 5-ST - 1754504



PCB connector, nominal cross section: 2.5 mm<sup>2</sup>, color: green, nominal current: 12 A, rated voltage (III/2): 320 V, contact surface: Tin, type of contact: Female connector, Number of potentials: 5, Number of rows: 1, Number of positions per row: 5, number of connections: 5, product range: MSTB 2,5/..-ST, pitch: 5 mm, connection method: Screw connection with tension sleeve, conductor/PCB connection direction: 0 °, Stecksystem: CLASSIC COMBICON, Locking: without, type of packaging: packed in cardboard

## Printed-circuit board connector - MSTBA 2,5/ 5-G - 1757501

### Accessories

#### Printed-circuit board connector - MSTBP 2,5/ 5-ST - 1765807



PCB connector, nominal cross section: 2.5 mm<sup>2</sup>, color: green, nominal current: 12 A, rated voltage (III/2): 320 V, contact surface: Tin, type of contact: Female connector, Number of potentials: 5, Number of rows: 1, Number of positions per row: 5, number of connections: 5, product range: MSTBP 2,5/..-ST, pitch: 5 mm, connection method: Screw connection with tension sleeve, conductor/PCB connection direction: 0 °, Stecksystem: CLASSIC COMBICON, Locking: without, type of packaging: packed in cardboard

#### Printed-circuit board connector - SMSTB 2,5/ 5-ST - 1768794



PCB connector, nominal cross section: 2.5 mm<sup>2</sup>, color: green, nominal current: 12 A, rated voltage (III/2): 320 V, contact surface: Tin, type of contact: Female connector, Number of potentials: 5, Number of rows: 1, Number of positions per row: 5, number of connections: 5, product range: SMSTB 2,5/..-ST, pitch: 5 mm, connection method: Screw connection with tension sleeve, conductor/PCB connection direction: -45 °, Stecksystem: CLASSIC COMBICON, Locking: without, type of packaging: packed in cardboard

#### Printed-circuit board connector - FRONT-MSTB 2,5/ 5-ST - 1779440



PCB connector, nominal cross section: 2.5 mm<sup>2</sup>, color: green, nominal current: 12 A, rated voltage (III/2): 320 V, contact surface: Tin, type of contact: Female connector, Number of potentials: 5, Number of rows: 1, Number of positions per row: 5, number of connections: 5, product range: FRONT-MSTB 2,5/..-ST, pitch: 5 mm, connection method: Front screw connection, conductor/PCB connection direction: 0 °, Stecksystem: CLASSIC COMBICON, Locking: without, type of packaging: packed in cardboard

#### Printed-circuit board connector - MSTBT 2,5/ 5-ST - 1779864



PCB connector, nominal cross section: 2.5 mm<sup>2</sup>, color: green, nominal current: 12 A, rated voltage (III/2): 320 V, contact surface: Tin, type of contact: Female connector, Number of potentials: 5, Number of rows: 1, Number of positions per row: 5, number of connections: 5, product range: MSTBT 2,5/..-ST, pitch: 5 mm, connection method: Screw connection with tension sleeve, conductor/PCB connection direction: 0 °, Stecksystem: CLASSIC COMBICON, Locking: without, type of packaging: packed in cardboard

#### Printed-circuit board connector - MVSTBR 2,5/ 5-ST - 1792045



PCB connector, nominal cross section: 2.5 mm<sup>2</sup>, color: green, nominal current: 12 A, rated voltage (III/2): 320 V, contact surface: Tin, type of contact: Female connector, Number of potentials: 5, Number of rows: 1, Number of positions per row: 5, number of connections: 5, product range: MVSTBR 2,5/..-ST, pitch: 5 mm, connection method: Screw connection with tension sleeve, conductor/PCB connection direction: 90 °, Stecksystem: CLASSIC COMBICON, Locking: without, type of packaging: packed in cardboard

## Printed-circuit board connector - MSTBA 2,5/ 5-G - 1757501

### Accessories

#### Printed-circuit board connector - MVSTBW 2,5/ 5-ST - 1792553



PCB connector, nominal cross section: 2.5 mm<sup>2</sup>, color: green, nominal current: 12 A, rated voltage (III/2): 320 V, contact surface: Tin, type of contact: Female connector, Number of potentials: 5, Number of rows: 1, Number of positions per row: 5, number of connections: 5, product range: MVSTBW 2,5/..-ST, pitch: 5 mm, connection method: Screw connection with tension sleeve, conductor/PCB connection direction: -90 °, Stecksystem: CLASSIC COMBICON, Locking: without, type of packaging: packed in cardboard

#### Printed-circuit board connector - FKCT 2,5/ 5-ST - 1909249



PCB connector, nominal cross section: 2.5 mm<sup>2</sup>, color: green, nominal current: 12 A, rated voltage (III/2): 320 V, contact surface: Tin, type of contact: Female connector, Number of potentials: 5, Number of rows: 1, Number of positions per row: 5, number of connections: 5, product range: FKCT 2,5/..-ST, pitch: 5 mm, connection method: Push-in spring connection, conductor/PCB connection direction: 0 °, Stecksystem: CLASSIC COMBICON, Locking: without, type of packaging: packed in cardboard

#### Printed-circuit board connector - FKCVR 2,5/ 5-ST - 1909744



PCB connector, nominal cross section: 2.5 mm<sup>2</sup>, color: green, nominal current: 12 A, rated voltage (III/2): 320 V, contact surface: Tin, type of contact: Female connector, Number of potentials: 5, Number of rows: 1, Number of positions per row: 5, number of connections: 5, product range: FKCVR 2,5/..-ST, pitch: 5 mm, connection method: Push-in spring connection, conductor/PCB connection direction: 90 °, Stecksystem: CLASSIC COMBICON, Locking: without, type of packaging: packed in cardboard

#### Printed-circuit board connector - FKCVW 2,5/ 5-ST - 1910063



PCB connector, nominal cross section: 2.5 mm<sup>2</sup>, color: green, nominal current: 12 A, rated voltage (III/2): 320 V, contact surface: Tin, type of contact: Female connector, Number of potentials: 5, Number of rows: 1, Number of positions per row: 5, number of connections: 5, product range: FKCVW 2,5/..-ST, pitch: 5 mm, connection method: Push-in spring connection, conductor/PCB connection direction: -90 °, Stecksystem: CLASSIC COMBICON, Locking: without, type of packaging: packed in cardboard

#### Printed-circuit board connector - FKC 2,5/ 5-ST - 1910380



PCB connector, nominal cross section: 2.5 mm<sup>2</sup>, color: green, nominal current: 12 A, rated voltage (III/2): 320 V, contact surface: Tin, type of contact: Female connector, Number of potentials: 5, Number of rows: 1, Number of positions per row: 5, number of connections: 5, product range: FKC 2,5/..-ST, pitch: 5 mm, connection method: Push-in spring connection, conductor/PCB connection direction: 0 °, Stecksystem: CLASSIC COMBICON, Locking: without, type of packaging: packed in cardboard

## Printed-circuit board connector - MSTBA 2,5/ 5-G - 1757501

### Accessories

#### Printed-circuit board connector - QC 1/ 5-ST-BUS - 1921706



PCB connector, nominal cross section: 1 mm<sup>2</sup>, color: green, nominal current: 10 A, rated voltage (III/2): 630 V, contact surface: Tin, type of contact: Female connector, Number of potentials: 5, Number of rows: 1, Number of positions per row: 5, number of connections: 5, product range: QC 1/..-ST-BUS, pitch: 5 mm, connection method: Displacement connection, conductor/PCB connection direction: 90 °, Stecksystem: CLASSIC COMBICON, Locking: without, type of packaging: packed in cardboard, The plug allows conductors to be looped through from module to module, without interruption

---

#### Printed-circuit board connector - FKCS 2,5/ 5-ST - 1974766



PCB connector, nominal cross section: 2.5 mm<sup>2</sup>, color: green, nominal current: 12 A, rated voltage (III/2): 320 V, contact surface: Tin, type of contact: Female connector, Number of potentials: 5, Number of rows: 1, Number of positions per row: 5, number of connections: 5, product range: FKCS 2,5/..-ST, pitch: 5 mm, connection method: Push-in spring connection, conductor/PCB connection direction: 0 °, Stecksystem: CLASSIC COMBICON, Locking: without, type of packaging: packed in cardboard

---

Phoenix Contact 2020 © - all rights reserved  
<http://www.phoenixcontact.com>

PHOENIX CONTACT GmbH & Co. KG  
Flachsmarktstr. 8  
32825 Blomberg  
Germany  
Tel. +49 5235 300  
Fax +49 5235 3 41200  
<http://www.phoenixcontact.com>